

6W isolated DC-DC converter in DIP package
Ultra-wide input and regulated dual/single output

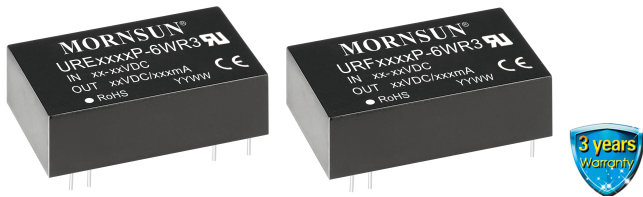

UL **CE** **CB** Patent Protection **RoHS**

FEATURES

- Ultra-wide 4:1 input voltage range
- High efficiency up to 88%
- No-load power consumption as low as 0.12W
- I/O isolation test voltage 3k VDC
- Operating ambient temperature range: -40°C to +85°C
- Input under-voltage protection, output short-circuit, over-voltage, over-current protection
- Meet CISPR32/EN55032 CLASS A, without extra components
- Industry standard pin-out
- IEC60950, UL60950, EN62368 approved

URE_P-6WR3 & URF_P-6WR3 series of isolated 6W DC-DC converter products with 4:1 input voltage. They feature efficiencies of up to 88%, 3000VDC input to output isolation, operating ambient temperature of -40°C to +85°C, input under-voltage protection, output short-circuit protection. The products meet CLASS A of CISPR32/EN55032 EMI standards, they are widely used in applications such as industrial control, electrical power, instrumentation and telecommunication fields.

Selection Guide

Certification	Part No.	Input Voltage (VDC)		Output		Full Load Efficiency ^② (%) Min./Typ.	Capacitive Load ^③ (μF) Max.
		Nominal (Range)	Max. ^①	Voltage (VDC)	Current (mA) Max./Min.		
UL/CE/CB	URE2405P-6WR3	24 (9-36)	40	±5	±600/0	78/80	680
	URE2412P-6WR3			±12	±250/0	81/83	330
	URE2415P-6WR3			±15	±200/0	82/84	220
	URF2403P-6WR3			3.3	1500/0	76/78	2200
	URF2405P-6WR3			5	1200/0	79/81	2200
	URF2409P-6WR3			9	667/0	82/84	1000
	URF2412P-6WR3			12	500/0	82/84	680
	URF2415P-6WR3			15	400/0	84/86	680
	URF2424P-6WR3			24	250/0	84/86	680
--	URF2425P-6WR3			25	240/0	83/85	680
UL/CE/CB	URF4803P-6WR3	48 (18-75)	80	3.3	1500/0	77/79	2200
	URF4805P-6WR3			5	1200/0	81/83	2200
	URF4812P-6WR3			12	500/0	85/87	680
	URF4815P-6WR3			15	400/0	86/88	680
	URF4824P-6WR3			24	250/0	85/87	680

- Notes:
- ① Exceeding the maximum input voltage may cause permanent damage;
 - ② Efficiency is measured at nominal input voltage and rated output load;
 - ③ The specified maximum capacitive load for positive and negative output is identical.

Input Specifications

Item	Operating Conditions	Min.	Typ.	Max.	Unit	
Input Current (full load / no-load)	24VDC Input	3.3V output	--	320/10	329/16	mA
		Others	--	298/10	320/16	
	48VDC Input	3.3V output	--	158/4	162/7	
		Others	--	147/4	154/7	
Reflected Ripple Current	24VDC Input	--	20	--	VDC	
	48VDC Input	--	20	--		
Surge Voltage (1sec. max.)	24VDC Input	-0.7	--	50	VDC	
	48VDC Input	-0.7	--	100		

Start-up Voltage	24VDC Input	--	--	9	VDC
	48VDC Input	--	--	18	
Input Under-voltage Protection	24VDC Input	5.5	6.5	--	
	48VDC Input	12	15.5	--	
Start-up Time	Nominal input& constant resistance load	--	10	--	ms
Input Filter		Pi filter			
Hot Plug		Unavailable			

Output Specifications

Item	Operating Conditions	Min.	Typ.	Max.	Unit	
Voltage Accuracy	5%-100% load	--	±1	±3		
	0%-5% load	Single output	--	±1		±3
		Dual output	--	±2		±5
Balance of Output Voltage	Dual output, balanced load	--	±0.5	±1.5		
Linear Regulation	Input voltage variation from low to high at full load	Vo1	--	±0.2	±0.5	%
		Vo2	--	±0.5	±1	
Load Regulation ^①	5%-100% load	Vo1	--	±0.5	±1	
		Vo2	--	±0.5	±1.5	
Cross Regulation	Dual output, Vo1 load at 50%, Vo2 load at range of 10%-100%	--	--	±5		
Transient Recovery Time	25% load step change	--	300	500	μs	
Transient Response Deviation		--	±3	±5	%	
Temperature Coefficient	Full load	--	--	±0.03	%/°C	
Ripple&Noise ^②	20MHz bandwidth, 5%-100% load	--	85	120	mVp-p	
Over-voltage Protection	Input voltage range	110	--	160	%Vo	
Over-current Protection	Input voltage range	24V output	110	220	290	%Io
		Others	110	140	190	
Short-circuit Protection	Input voltage range	Continuous, self-recovery				

Note:①Load regulation for 0%-100% load is ±5%;

②Ripple & Noise at ≤ 5% load is 5%Vo. Max. The "parallel cable" method is used for ripple and noise test, please refer to *DC-DC Converter Application Notes* for specific information.

General Specifications

Item	Operating Conditions	Min.	Typ.	Max.	Unit
Isolation	Input-output Electric Strength test for 1 minute with a leakage current of 1mA max.	3000	--	--	VDC
Isolation Resistance	Input-output resistance at 500VDC	1000	--	--	MΩ
Isolation Capacitance	Input-output capacitance at 100kHz/0.1V	--	1000	--	pF
Operating Temperature	Derating when operating temperature up to 71°C (see Fig. 1)	-40	--	85	°C
Storage Temperature		-55	--	125	
Storage Humidity	Non-condensing	5	--	95	%RH
Pin Soldering Resistance Temperature	Soldering spot is 1.5mm away from case for 10 seconds	--	--	300	°C
Vibration		10-55Hz, 2G, 30 Min. along X, Y and Z			
Switching Frequency	PWM mode	--	300	--	kHz
MTBF	MIL-HDBK-217F@25°C	1000	--	--	k hours

Note:*Switching frequency is measured at full load. The module reduces the switching frequency for light load (below 50%) efficiency improvement.

Mechanical Specifications

Case Material	Black plastic; flame-retardant and heat-resistant (UL94-V0)
Dimensions	31.60 x 20.30 x 10.20 mm
Weight	13g(Typ.)
Cooling method	Free air convection

Electromagnetic Compatibility (EMC)

Emissions	CE	CISPR32/EN55032	CLASS A (without extra components)/ CLASS B (see Fig.3-② for recommended circuit)
	RE	CISPR32/EN55032	CLASS A (without extra components)/ CLASS B (see Fig.3-② for recommended circuit)
Immunity	ESD	IEC/EN61000-4-2	Contact ±4kV perf. Criteria B
	RS	IEC/EN61000-4-3	10V/m perf. Criteria A
	EFT	IEC/EN61000-4-4	±2kV (see Fig.3-① for recommended circuit) perf. Criteria B
	Surge	IEC/EN61000-4-5	±2kV (see Fig.3-① for recommended circuit) perf. Criteria B
	CS	IEC/EN61000-4-6	3 Vr.m.s perf. Criteria A
Voltage dips, short interruptions and voltage variations immunity		IEC/EN61000-4-29	0-70% perf. Criteria B

Typical Characteristic Curves

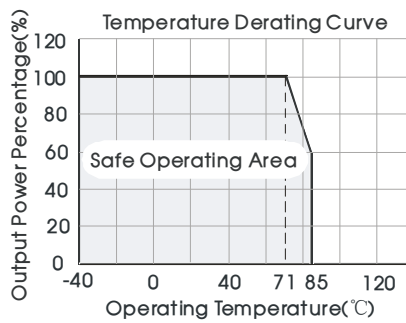
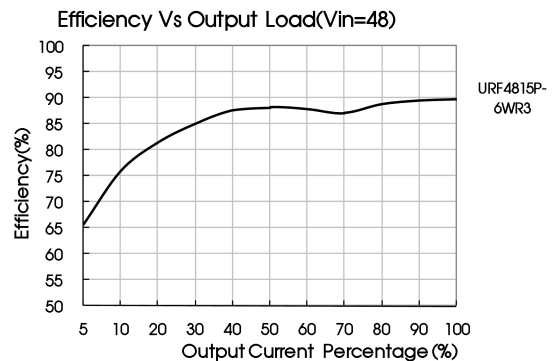
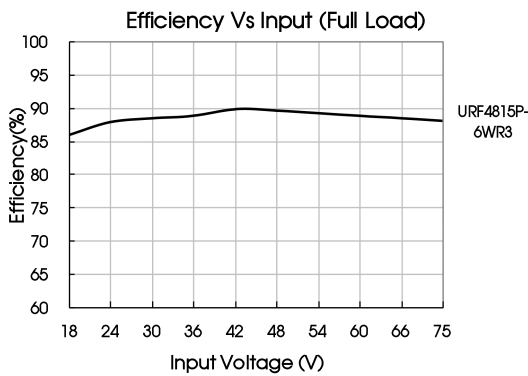
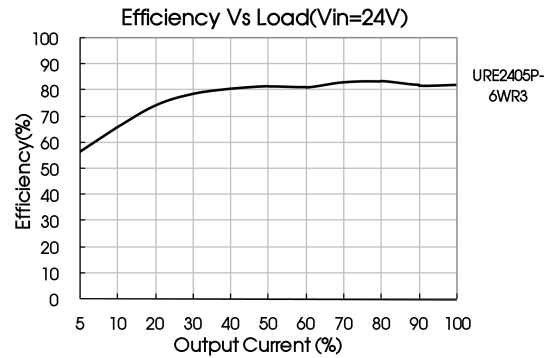
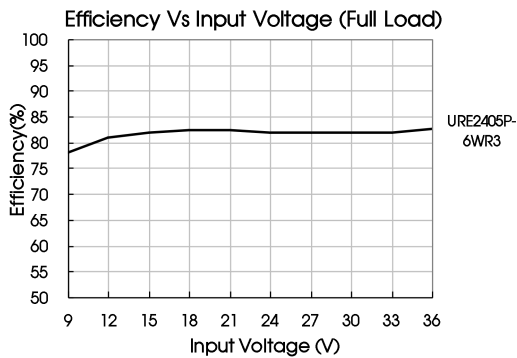

Fig. 1



Design Reference

1. Typical application

All the DC/DC converters of this series are tested before delivery using the recommended circuit shown in Fig. 2.

Input and/or output ripple can be further reduced by appropriately increasing the input & output capacitor values C_{in} and C_{out} and/or by selecting capacitors with a low ESR (equivalent series resistance). Also make sure that the capacitance is not exceeding the specified max. capacitive load value of the product.

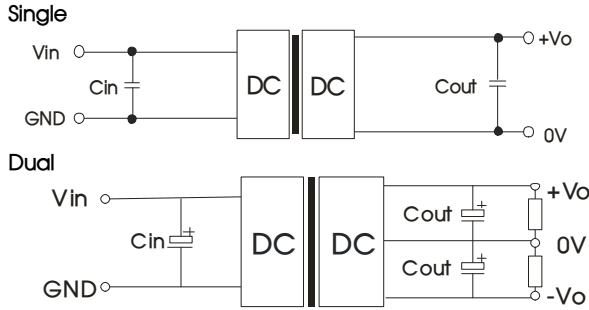

Fig. 2

Vin(VDC)	Cin	Vo(VDC)	Cout
24	100µF/50V	±5/3.3/5/9	10µF/16V
		±12/±15/12/15	10µF/25V
		24/25	10µF/50V
48	10µF/100V ~ 47µF/100V	3.3/5	10µF/16V
		12/15	10µF/25V
		24	10µF/50V

2. EMC compliance circuit

URE_P-6WR3 & URF_P-6WR3:

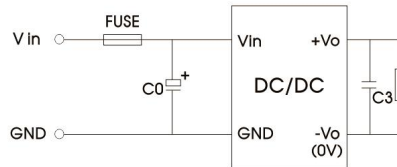
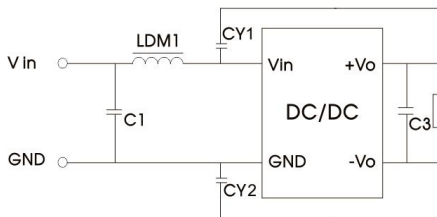

Fig. 3-①

URE_P-6WR3:



URF_P-6WR3:

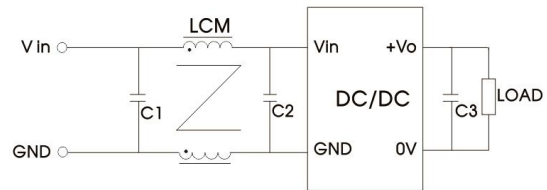

Fig. 3-②

Notes: For EMC tests we use Part ① in Fig. 3 for immunity and part ② for emissions test. Selecting based on needs.

Parameter description

URE_P-6WR3	
Model	Vin:24VDC
FUSE	Choose according to actual input current
C0	1000µF/50V
C1	1µF/50V
C3	Refer to the Cout in Fig.2
LDM1	4.7µH
CY1/CY2	1nF/3kV

Parameter description

URF_P-6WR3		
Model	Vin:24VDC	Vin:48VDC
FUSE	Choose according to actual input current	
C0	1000µF/50V	680µF/100V
C1/C2	2.2µF/50V	2.2µF/100V
LCM	2.2 mH, recommended to use MORNSUN's FL2D-30-222	
C3	Refer to the Cout in Fig.2	

3. The products do not support parallel connection of their output

4. For additional information please find DC-DC converter application notes on www.mornsun-power.com

Dimensions and Recommended Layout

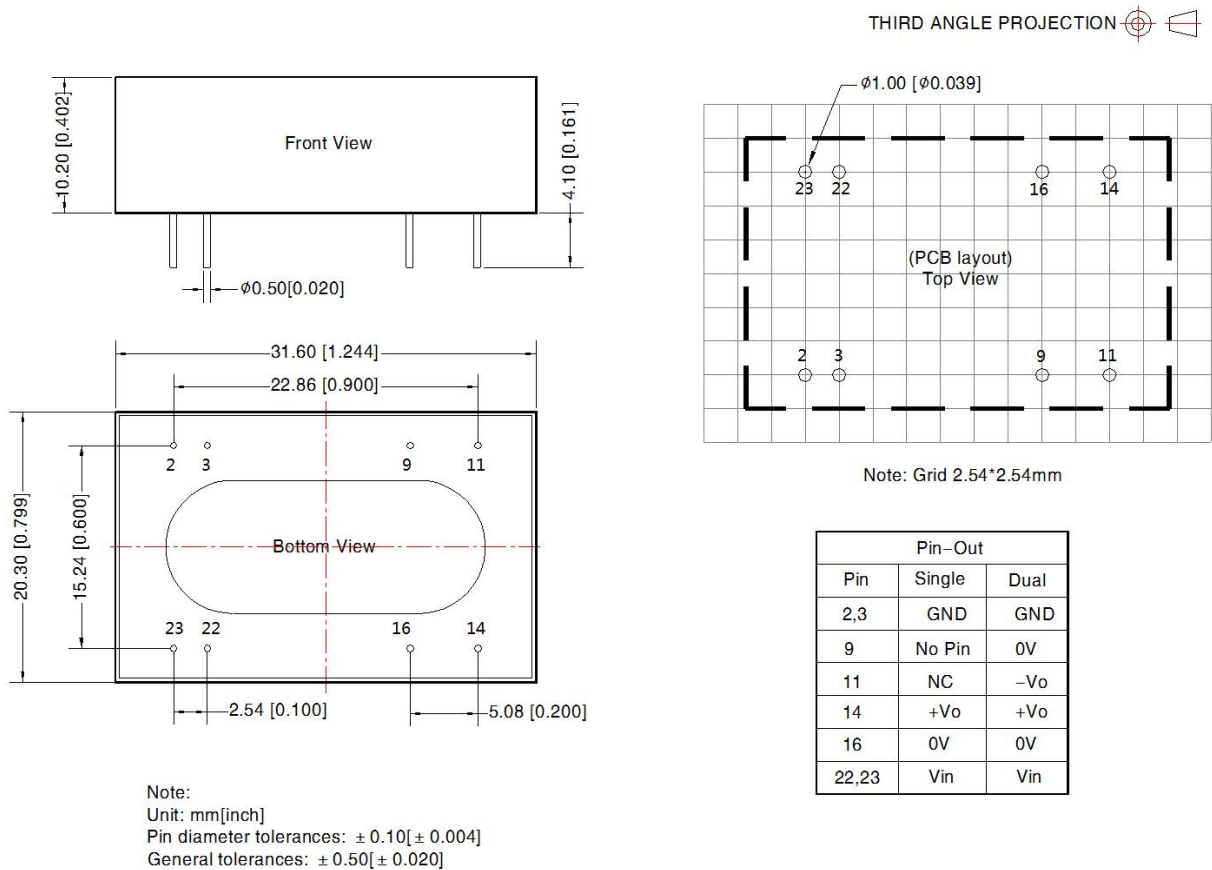

- Note:
- For additional information on Product Packaging please refer to www.mornsun-power.com. Packaging number: 58210008;
 - The maximum capacitive load offered were tested at input voltage range and full load;
 - Unless otherwise specified, parameters in this datasheet were measured under the conditions of $T_a=25^{\circ}\text{C}$, humidity<75%RH with nominal input voltage and rated output load;
 - The recommended unbalance degree of the dual output module load is $\leq \pm 5\%$; if the degree exceeds $\pm 5\%$, than the product performance cannot be guaranteed to comply with all parameters in the datasheet. Please contact our technicians directly for specific information;
 - All index testing methods in this datasheet are based on our company corporate standards;
 - The performance indexes of the product models listed in this datasheet are as above, but some indexes of non-standard model products will exceed the above-mentioned requirements, and please directly contact our technicians for specific information;
 - We can provide product customization service;
 - Products are related to laws and regulations: see "Features" and "EMC";
 - Our products shall be classified according to ISO14001 and related environmental laws and regulations, and shall be handled by qualified units.

Mornsun Guangzhou Science & Technology Co., Ltd.

Address: No. 5, Kehui St. 1, Kehui Development Center, Science Ave., Guangzhou Science City, Huangpu District, Guangzhou, P. R. China
Tel: 86-20-38601850 Fax: 86-20-38601272 E-mail: info@mornsun.cn www.mornsun-power.com